

 DESIGN

 MANUFACTURING

 SERVICE

## FINISHING, COATING AND LAMINATING MACHINERY





### POWDER SCATTER HEAD

Scattering of thermoplastic powders, at different granulometry and glitters. High precision and easy to use. Suitable for thermoplastic powders or glitters. The unit can be synchronized with the line speed. The unit can be equipped with an automatic side to side powder distributor, with level control



### POWDER SCATTER HEAD - MODEL NEW SPRAY

Antonio e fratelli Zappa S.A.S.  
Partita I.V.A. 00202820130  
Via Trieste, 11 - 22037  
Ponte Lambro (Como) Italy

+39 031/620327   
+39 031/621926   
central@fratellizappa.191.it   
www.zappamacchine.com 



# POWDER SCATTER HEAD

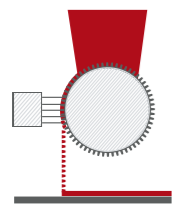

## MODEL NEW SPRAY SUITABLE FOR SCATTERING THERMOPLASTIC POWDERS OR GLITTERS

Against the surface of the card cloth roller, an oscillating brush assembly will remove the powder from the card cloth and a special open mesh screen will distribute regularly on the fabric.

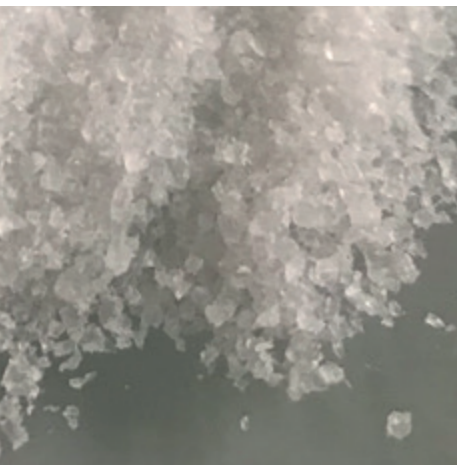

### TECHNICAL DATA

- Web width: up to 6.000 mm.
- Mechanical speed range: 0 ÷ 15 rpm (of the card cloth roller)
- Electrical supply: 400V 50Hz (or different when specified)
- Electric plant: in conformity with the EU regulations
- Powder particle size: the standard card cloth roller is suitable for powder 80 ÷ 600 µm, for different size of powder the machine must be equipped with a different roller.
- Powder deposition range: 0 ÷ 3000 g / lin. mt / min.



### LAMINATING LINE WITH IR-OVEN AND CALENDER

- LOW INVESTMENT COST
- HIGHLY RECOMENDED FOR THICK MATERIALS

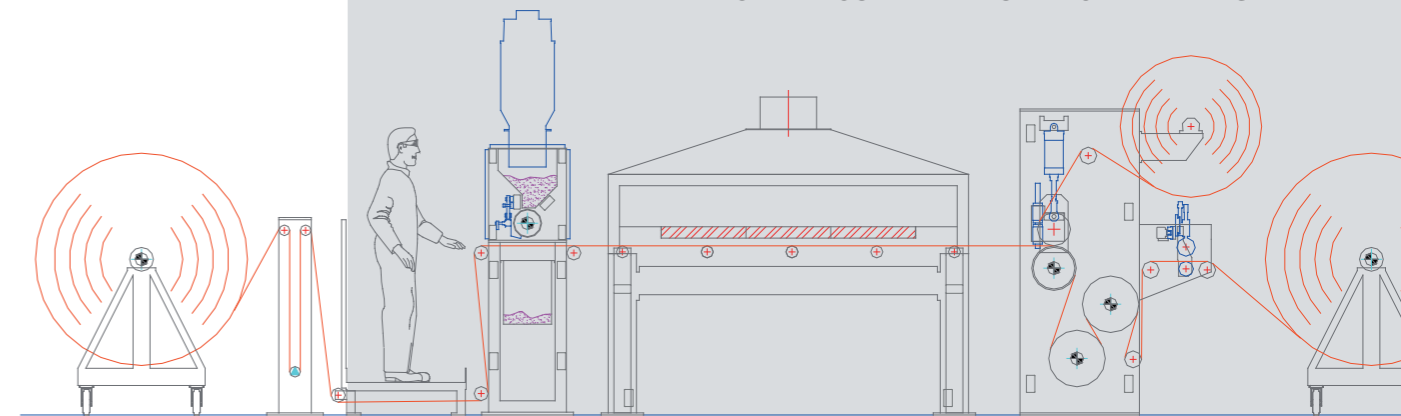

### LAMINATION LINE WITH FLATBED

- FOR FLEXIBLE AND NON FLEXIBLE MATERIAL

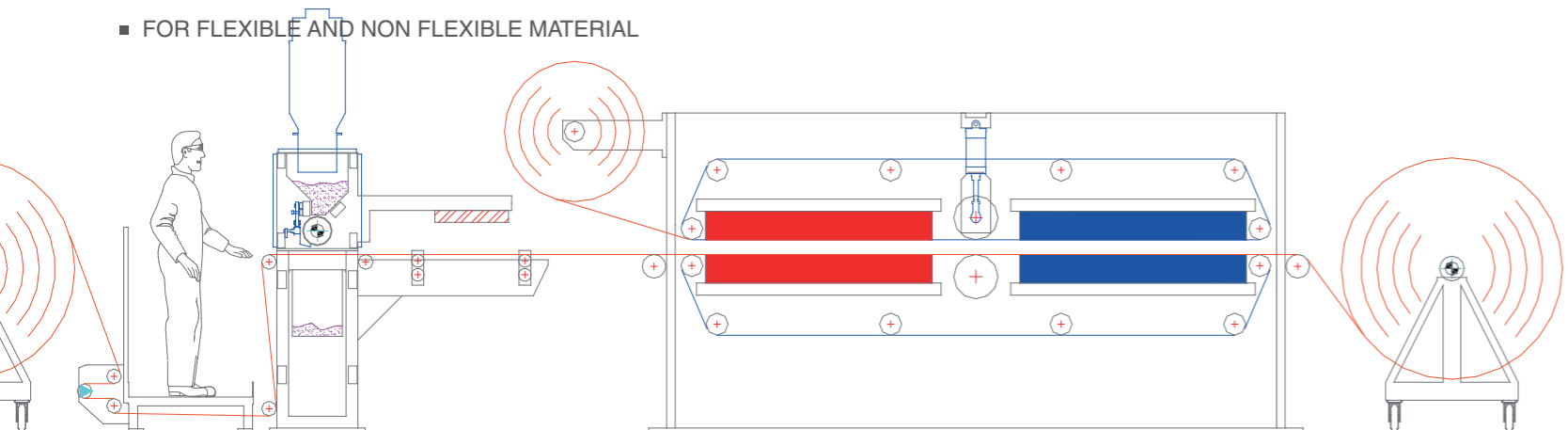

### LAMINATION LINE WITH BELT CALENDER

- BETTER FOR SYNTETIC MATERIAL
- LINE SPEED OPTIMIZATION

